



Closure Plan

**Alma Offsite Disposal Facility,
Phase IV Landfill
Alma, Wisconsin**

January 2023

Prepared For:

Dairyland Power Cooperative
3200 East Avenue South
La Crosse, Wisconsin 54601

Prepared By:

TRC
999 Fourier Drive, Suite 101
Madison, Wisconsin 53717

A handwritten signature in blue ink that reads "BreAnne Kahnk".

BreAnne Kahnk, P.E.
Senior Engineer

A handwritten signature in blue ink that reads "Todd W. Martin".

Todd W. Martin
Principal Project Manager



TABLE OF CONTENTS

REVISION HISTORY	II
1.0 INTRODUCTION.....	1
2.0 CLOSURE PLAN	2
2.1 Initiation of Closure Activities	2
2.2 Closure Performance Standard	2
2.3 Final Cover System.....	2
2.3.1 Final Cover Construction	4
2.3.1.1 Fine Grading the Waste Subbase	4
2.3.1.2 Soil Barrier Layer and GCL	4
2.3.1.3 Select CCR Layer.....	5
2.3.1.4 40-mil LLDPE Geomembrane	5
2.3.1.5 Granular Drainage Layer.....	5
2.3.1.6 General Fill Rooting Layer.....	6
2.3.1.7 Topsoil and Vegetation.....	6
2.3.2 Storm Water Control Features	6
2.4 Completion of Closure Activities	6
2.5 Amendment of a Written Closure Plan.....	7
3.0 NOTIFICATION.....	8
3.1 Operating Record.....	8
3.2 Notification Requirements	8
3.3 Publicly Accessible Internet Site	8
4.0 REFERENCES.....	10
5.0 ENGINEER’S CERTIFICATIONS.....	11

TABLES

Table 1: Schedule Estimate for Completing Closure

APPENDICES

Appendix A: Engineering Drawings

Revision History

Revision Number	Revision Date	Section Revised	Summary of Revisions
1	01/12/2023	1-3	Text updates.



1.0 Introduction

This Closure Plan (Plan) was prepared by TRC Environmental Corporation (TRC) on behalf of Dairyland Power Cooperative (DPC) for the Alma Off-Site Disposal Facility, Phase IV Landfill (Landfill) where coal combustion residuals (CCR) are disposed. The approximately 32.1 acres Landfill is located in Sections 18 and 19, T21N, R12W, Town of Belvidere, Buffalo County, Wisconsin. DPC owns and operates the Landfill in compliance with the Plan of Operation (RMT 2000) as permitted by the Wisconsin Department of Natural Resources (WDNR).

This Plan meets the closure requirements of the U.S. Environmental Protection Agency's (USEPA) CCR Rule, Title 40 Code of Federal Regulations (40 CFR) Parts 257 and 261 Subpart D - "Standards for the Disposal of Coal Combustion Residuals in Landfills and Surface Impoundments" as well as ch. NR 500-520, Wisconsin Administrative Code. The Landfill is considered an existing CCR landfill according to the CCR rule (40 CFR 257.53).

DPC plans to close the Landfill by leaving the CCR in-place upon completion of CCR placement. The Landfill is operated by moisture conditioning CCR, placing, and compacting the waste in the active area. Final cover will be installed in phases as portions of the Landfill reach the design top of waste grades. The Landfill has a design waste capacity of 3,011,000 cubic yards. Based on the phasing in the Plan of Operation (RMT, 2000), the largest proposed active area to be closed for the Landfill is approximately 12.4 acres. Based on the available capacity and current filling at the Landfill, it is anticipated that closure will be initiated in 2057. This closure date is subject to change based on potential changes in volume of CCR accepted at the Landfill.

2.0 Closure Plan

2.1 Initiation of Closure Activities

The owner or operator of the CCR unit shall initiate closure no later than 30 days after the date on which the CCR unit either receives the known final receipt of waste or removes the known final volume of CCR for beneficial use in accordance with 40 CFR 257.102(e) and s. NR 506.083(2). Closure shall also be commenced if the unit has not received waste or is no longer removing CCR for beneficial use within two years of last receipt of waste or last removal for beneficial use. The owner or operator may secure an additional 2 years so long as they are able to demonstrate that there is reasonable likelihood that the unit will accept waste or remove CCR in the foreseeable future. Subsequent 2-year periods may be continued to be requested so long as they are able to continue to demonstrate the reasonable likelihood of CCR waste disposal or removal for beneficial use. Demonstrations must be placed in the operating record prior to the end of any two-year period following 40 CFR 257.102(e)(2)(ii and iii). Per s. NR 506.083(2)(b), these delays shall be requested in writing to the WDNR as a modification to the Closure Plan and include the requirements detailed in s. NR 506.083(2)(b)(1-3).

No later than the date of initiating closure, the owner or operator must prepare a notification of intent to close the Landfill including the certification of a qualified professional engineer for the final cover system design as required by 40 CFR 257.102(d)(3)(iii).

Closure activities have been initiated if the owner or operator has ceased placing waste and completes one of the following activities:

- Taken steps necessary to implement the written closure plan,
- Submitted a completed application for required state or agency permit or modification, or
- Taken steps necessary to comply with state or other agency standards that are pre-requisite to initiating or completing closure.

2.2 Closure Performance Standard

The owner or operator of the Landfill will close the CCR unit in a manner that controls post-closure infiltration of liquids into the waste, releases of waste, and leachate or contaminated run-off to groundwater or surface water and preclude the probability of impoundment of water, sediment, or slurry. Measures will be included that provide slope stability which will prevent movement of the final cover system during closure and post-closure. Need for further maintenance of the CCR unit will be minimized. The CCR unit closure should be completed in the shortest amount of time consistent with recognized and generally accepted engineering practices and be done in accordance with 40 CFR 257.102 and s. NR 506.083.

2.3 Final Cover System

Closure of the Landfill will occur by leaving the CCR in-place, which requires the construction of a final cover system compliant with 40 CFR 257.102(d) and s. NR 504.12(4). The final cover system shall meet the following requirements:

- Designed to be compliant with s. NR 504.07, or

- The hydraulic conductivity of the final cover must be less than or equal to 1×10^{-5} centimeters per second (cm/s), or less than or equal to the hydraulic conductivity of the bottom liner system or natural subsoils present, whichever is less.
- An infiltration layer of at least 18 inches of earthen material that meets the requirements of s. NR 504.12(4)(b)(2).
- An erosion layer of at least six inches of earthen material that is capable of sustaining native plant growth that meets the requirements of s. NR 504.12(4)(b)(3).
- The final cover system must be designed to minimize impacts due to settling and subsidence.

The Landfill will be closed using a composite final cover system. Two final cover system options have been previously approved for the Landfill. These consist of the WDNR design presented in the Plan of Operation Conditional Approval (from bottom to top):

- a 24-inch compacted soil barrier (barrier layer),
- GCL (barrier layer),
- a 40-mil textured linear low density polyethylene (LLDPE) geomembrane (barrier layer),
- a 12-inch-thick select granular fill drainage layer (infiltration layer),
- an 18-inch-thick general fill rooting layer (infiltration layer), and
- a 6-inch-thick topsoil layer (erosion layer).

The 2004 Plan of Operation Modification presented a modified final cover system, which has been used in the previous three final cover construction events. This modified final cover system consists of the following components (from bottom to top):

- 2-foot (24 inches) moisture-conditioned and compacted “select” fly ash (i.e. mixture containing a minimum of 40 percent of the more reactive J.P. Madgett fly ash) (barrier layer),
- 40-mil geomembrane (barrier layer),
- 1-foot-thick (12 inches) sand drainage layer (infiltration layer),
- 1.5-foot-thick (18 inches) general soil cover layer (infiltration layer), and
- 6-inch-thick topsoil layer (erosion layer).

The modified final cover system provides a total of 3 feet of soil above the geosynthetics. The general function of each component of the final cover system is provided in parentheses above. The barrier layer consists of 2 feet of compacted select CCR and a 40-mil geomembrane which exceeds the hydraulic conductivity criteria of 1×10^{-5} cm/s. The landfill was constructed with a composite liner system; therefore, a composite final cover system provides an equivalent hydraulic conductivity. The granular fill drainage layer removes water that infiltrates through the erosion and infiltration layers. The infiltration layer and erosion layer meet the requirements of

the CCR rule and s. NR 504.07(6) and (7). This final cover system meets the requirements of 40 CFR 257.102(d)(3)(i) and s. NR 504.12(4).

Following placement of final cover and the surface water control features, the area will be fertilized, seeded, and mulched in order to establish vegetation.

The final cover system has design slopes of 25 percent, refer to Sheet 12 from the Plan of Operation in Appendix A. Because the waste is placed and compacted with control of the moisture conditions and the stability of CCR, significant settlement is not anticipated. Global stability of the Landfill and interface stability of the final cover system were evaluated in the Plan of Operation (RMT 2000) with resulting factors of safety that meet the CCR rule. Based on these considerations, the Landfill closure has been designed in a manner to minimize or eliminate infiltration into the waste, preclude the probability of future impoundment of water, provide stable slopes, and minimize future maintenance.

2.3.1 Final Cover Construction

The final cover system will be constructed in phases as the top-of-waste grades are achieved to minimize the active area of the Landfill and leachate generation. After final CCR placement in the Landfill, the remaining portion of the final cover system will be constructed. Surface water control features on this segment of the final cover will be constructed and connected with the existing surface water control features.

The final cover will be constructed by fine grading the waste subbase, placing the soil barrier layer and GCL or placing and compacting the 2 foot thick select CCR material, deploying and installing the 40-mil thick textured geomembrane, placing the granular drainage layer, placing the general fill rooting layer, and placing the topsoil layer. A schedule estimate of closure activities is presented in Table 1. It is anticipated that closure construction can be completed within the 6-month required timeframe.

2.3.1.1 Fine Grading the Waste Subbase

The waste subbase will be fine graded and leveled using heavy equipment to provide a surface for the placement of the grading layer and GCL.

2.3.1.2 Soil Barrier Layer and GCL

The soil barrier layer material, if used, will meet the requirements specified in Condition 11b of the Plan of Operation Conditional Approval. The soil barrier layer will have a minimum thickness of 24 inches measured vertically from the top of the ash waste.

The GCL will be deployed above the soil barrier layer such that there is a minimum of 6 inches of overlap on longitudinal seams and a minimum of 24 inches overlap on end seams or as recommended by the manufacturer, whichever is greater. The panels will be placed with the overlap on both longitudinal and end seams shingled down-slope. If the GCL requires granular bentonite to be placed along the seam, the overlapping panel edge will be pulled back and granular sodium bentonite will be poured continuously along all seams, at an application rate of ¼ pound per linear foot.

The GCL will be tested during manufacturing, and prior to installation. The results of manufacturer's testing will be submitted to the engineer for review and approval prior to the acceptance of GCL. Samples from selected rolls delivered to the site will also be collected for conformance testing prior to acceptance and installation.

2.3.1.3 Select CCR Layer

The select CCR layer will be moisture conditioned and compacted according to the construction specifications. The compaction of the select CCR material will be observed by the engineer's representative that is documenting construction. The select CCR layer will have a minimum thickness of two feet measured vertically from the cover surface.

2.3.1.4 40-mil LLDPE Geomembrane

If GCL is used, the LLDPE geomembrane will be deployed at a rate equivalent to that of the GCL deployment rate such that the GCL panels will be covered daily to prevent against physical damage and/or hydration of the GCL. The geomembrane will be fabricated from a polyethylene resin, which will have a density range of 0.939 g/cc or less for LLDPE. The nominal geomembrane thickness will be 40 mils for LLDPE, with no thickness measurements falling below the minimum industry-accepted manufacturing tolerance.

The geomembrane will be installed with the panels orientated perpendicular to the contours (i.e., running up and down the slope). The geomembrane will be deployed in a manner that does not adversely impact the barrier material below the geomembrane.

Geomembrane panels will be seamed in the field. Production seaming (linear seams) will be performed using the dual hot wedge (fusion type) seam method. Non-production seams (detail work and repairs) will be performed using the extrusion fillet weld process. Corners, butt seams, and long repairs will be fusion-welded where possible. The geomembrane component of the adjacent cell will be welded together for a continuous membrane surface.

The geomembrane will be tested during manufacturing, and prior to and during installation. The results of the manufacturer's testing will be submitted for review and approval prior to the acceptance of geomembrane rolls delivered to the site. Samples from selected rolls delivered to the site will also be collected for conformance testing by a third-party laboratory prior to acceptance and installation. Finally, during placement, both nondestructive and destructive testing of the geomembrane seams will be performed. Nondestructive testing will be performed by the installation contractor and observed by a third party. Destructive testing will consist of both field and third-party laboratory testing of the samples collected

2.3.1.5 Granular Drainage Layer

After placement and testing of the geomembrane, or portions thereof, a 12-inch-thick select granular fill drainage layer will be placed as soon as practicable to protect the geomembrane and to provide a confining pressure for the underlying GCL, if used. At a minimum, the select granular fill will be placed within 30 days of completing the membrane installation and quality assurance testing.

To minimize the potential for large wrinkles in the geomembrane, the drainage layer will be placed during cooler temperatures when possible. Wrinkles in the geomembrane that are higher than they are wide, will be smoothed or cut out and repaired prior to placing the drainage layer.

The initial lift of select granular fill will be 2 to 3 feet thick, depending on the type of equipment being used, to provide an access ramp. A minimum of 2 feet of material will be placed prior to operating tracked vehicles and flotation tire-equipped vehicles, while a minimum of 3 feet of material will be placed prior to operating trucks and other wheeled hauling equipment. The initial lifts of select granular fill will eventually be graded to the designed 1-foot-thick layer with a low ground pressure (< 5 psi) tracked vehicle. The procedure for deployment of the granular drainage blanket will be established at the preconstruction meeting.

2.3.1.6 General Fill Rooting Layer

An 18-inch-thick uncompacted general fill rooting layer will be placed above the drainage layer in a single lift. The general fill rooting layer will provide a rooting zone for vegetation and will protect the cap from damage due to freeze-thaw and desiccation.

2.3.1.7 Topsoil and Vegetation

The top layer of the final cover system will be a 6-inch-thick layer of topsoil. Topsoil stripped from the landfill and perimeter areas during site preparation will be stockpiled and reused in the final cover. After topsoil is placed, the area will be seeded, mulched, and fertilized. Prior to seeding, the topsoil layer will be prepared for seeding by disking and pulverizing soil within 2 inches of the surface.

DPC has established prairie vegetation on previously constructed phases of final cover with good performance. The prairie vegetation is suitable to soil quality/thickness, and slopes and moisture conditions, with minimal need for continuous maintenance. This prairie vegetation is planned for use in future final cover construction events. Erosion control measures will be installed as needed across the site to limit erosion prior to establishing vegetation.

2.3.2 Storm Water Control Features

Storm water control features will be constructed and/or completed for each phase of final cover construction. Storm water control features consist of diversion berms, a downslope flumes, and energy dissipaters. These storm water control features on the final cover deliver water to perimeter ditches, sedimentation basins, and sediment traps that were constructed during liner construction of the various cells. The storm water control features will be constructed in accordance with the specifications and details presented in the Plan of Operation (RMT 2000), refer to Appendix A for relevant plan sheets from the Plan of Operation. These features are designed to manage runoff from 100-year 24-hour storm events and minimizing scour and erosion of the final cover. Additional details on the storm water control features are provided in the Run-On and Run-Off Control Systems Plan.

2.4 Completion of Closure Activities

Within 30 days of completion of closure activities the owner or operator shall prepare a notification of closure of a CCR unit with a certification from a qualified professional engineer that the closure has been performed in accordance with this Plan.

Per 40 CFR 257.102(i) the owner or operator must record a notation on the deed to the property, or some other instrument that is normally examined during title search, that the land has been used for a CCR unit and that it is restricted under the post-closure care requirements as provided in 40 CFR 257.104(d)(1)(iii). Per s. NR 506.083(4)(a), the deed notation (affidavit) is to be recorded within 60 days after closure is complete. A copy of the affidavit is required to be submitted to the WDNR and placed in the facility's operating record within 30 days of recordation.

2.5 Amendment of a Written Closure Plan

The owner or operator will amend the written closure plan in accordance with s. NR 514.04(6) whenever:

- There is a change in the operation of the Landfill that would substantially affect the plan in effect, or
- Before or after closure activities have commenced, unanticipated events necessitate a revision.

The closure plan must be amended and submitted in writing to the WDNR at least 60 days prior to a planned change in operation of the Landfill, or no later than 60 days after an unanticipated event occurs that requires the need to revise an existing closure plan. If a written closure plan is revised after closure activities have commenced for the Landfill, the current closure plan must be amended and submitted to the WDNR no later than 30 days following the triggering event.

3.0 Notification

3.1 Operating Record

The following items will be maintained in the operating record for a minimum of five years:

- 40 CFR 257.105(i)(4): the most recent written closure plan or amendment of the Plan must be maintained for the life of the operating record
- 40 CFR 257.105(i)(7): the notification of intent to close a CCR unit
- 40 CFR 257.105(i)(8): the notification of completion of closure of a CCR unit
- 40 CFR 257.105(i)(9): the notification of recording a notation on the deed

3.2 Notification Requirements

The following required notifications will be provided before the close of business on the day the notification is required to be completed:

- 40 CFR 257.106(i)(4)/s. NR 506.17(4)(c): a notification of the available written closure plan or amendment of the Plan
- 40 CFR 257.106(i)(7)/s. NR 506.083(1)(a): the notification of intent to close a CCR unit
- 40 CFR 257.106(i)(8) /s. NR 506.083(1)(b): the notification of completion of closure of a CCR unit
- 40 CFR 257.106(i)(9) /s. NR 506.083(4)(a): the notification of recording a notation on the deed

3.3 Publicly Accessible Internet Site

The following required items will be posted on the publicly accessible internet site within 30 days of placing the information in the operating record:

- 40 CFR 257.105(i)(4): the most recent written closure plan or amendment of the Plan must be maintained for the life of the operating record
- 40 CFR 257.107(i)(7): the notification of intent to close a CCR unit
- 40 CFR 257.107(i)(8): the notification of completion of closure of a CCR unit
- 40 CFR 257.106(i)(9): the notification of recording a notation on the deed

Information should be posted within 30 days of placing the pertinent information required by 40 CFR 257.105/NR 506.17(3)(c) in the operating record. Records will be made available to the public for at least five years following the date on which the information was posted to the internet site.



Additional postings to the operating record, notifications, and postings to the publicly accessible internet site may be needed if extensions under 40 CFR 257.102e(2)(ii) or 40 CFR 257.102(f)(2) are pursued.

4.0 References

RMT, Inc. 2000. Plan of Operation: Phase IV Disposal Area, Alma Off-site Ash Disposal Facility, Town of Belvidere, Buffalo County, Wisconsin. October 2000.

RMT, Inc. 2004. Plan of Operation Modification: Phase IV Disposal Area, Alma Off-site Disposal Facility, Town of Belvidere, Buffalo County, Wisconsin.

TRC Environmental Corporation. 2021. Run-On and Run-Off Control Systems Plan. October 2021.

5.0 Engineer's Certifications

Pursuant to 40 CFR 257.102 and by means of this certification I attest that:

- (i) I am familiar with the requirements of the CCR rule (40 CFR 257);
- (ii) I am familiar with the requirements of the ch. NR 500-520, Wisconsin Administrative Code;
- (iii) this Closure Plan has been prepared in accordance with good engineering practice;
- (iv) the design of the final cover system meets the requirements of 40 CFR 257.102(d)(3) and s. NR 504.12(4); and
- (v) this Closure Plan meets the requirements of 40 CFR 257.102 and s. NR 514.07(10)(c).

For the purpose of this document, "certify" and "certification" shall be interpreted and construed to be a "statement of professional opinion." The certification is understood and intended to be an expression of my professional opinion as a Wisconsin licensed professional engineer, based upon knowledge, information, and belief. The statement(s) of professional opinion are not and shall not be interpreted or construed to be a guarantee or a warranty of the analysis herein.

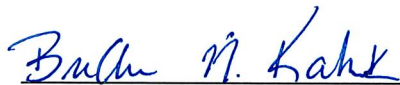

Signature of Registered Professional Engineer

Registration No. E-46825 State: Wisconsin





**Table 1: Schedule Estimate for Completing Closure
Closure Plan – Alma Offsite Disposal Facility, Phase IV Landfill**

Closure Area: 12.4 Acres - Remaining Portion of Final Cover on Plan of Operation Phasing Plans			
Task/Milestone	Start Date⁽¹⁾	Duration	Estimated End Date
Ash Filling Ceases	2/1/2057	--	2/1/2057
Notification to Initiate Closure	3/2/2057	--	3/2/2057
Fine Grading Waste	3/5/2057	22 days	3/26/2057
Select CCR Placement and Compaction ⁽²⁾	3/27/2057	31 days	4/26/2057
Geomembrane Deployment and Installation	4/27/2057	21 days	5/17/2057
Granular Drainage Layer Placement	5/18/2057	18 days	6/4/2057
General Fill Rooting Zone Placement	6/5/2057	21 days	6/25/2057
Topsoil Placement and Seeding	6/26/2057	11 days	7/6/2057
Notification of Completion of Closure	7/9/2057	31 days	8/8/2057
Deed Notation and Notification	7/9/2057	61 days	9/7/2057
Total Duration:		124 days⁽³⁾	

Footnotes:

- ⁽¹⁾ Start date based on assumed beginning of 2057 construction season. Closure construction may be shifted to different years based on rate of filling.
- ⁽²⁾ Previous final cover construction has utilized the modified final cover design. Timeframes associated for this modified final cover design will be used.
- ⁽³⁾ Total duration provided in time to substantial completion of final cover placement. At this point, the CCR has been covered and the vegetation seed and temporary erosion control has been applied. Emergence and establishment of vegetation may require additional time.

Created By: J. Hotstream
Checked By: S. Sellner

Revised by: B. Kahnk
Checked By: Z. Bauman

Appendix A: Engineering Drawings

- Plan of Operation – Title Sheet (Sheet 1)
- Plan of Operation – Final Grades (Sheet 12)
- Plan of Operation – Details – Final Cover (Sheet 19)
- Cell 3B Liner Construction and Area C (Over Cells 1 and 2) Final Cover Construction – Details (Sheets 12 and 13)

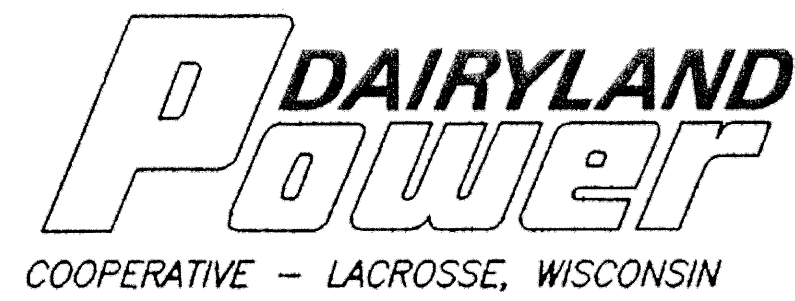

DAIRYLAND POWER COOPERATIVE

PLAN OF OPERATION PHASE IV DISPOSAL AREA ALMA OFF-SITE ASH DISPOSAL FACILITY

PREPARED FOR: DAIRYLAND POWER COOPERATIVE
LACROSSE, WISCONSIN

PREPARED BY: RMT, INC.
MADISON, WISCONSIN

DATE: OCTOBER 2000

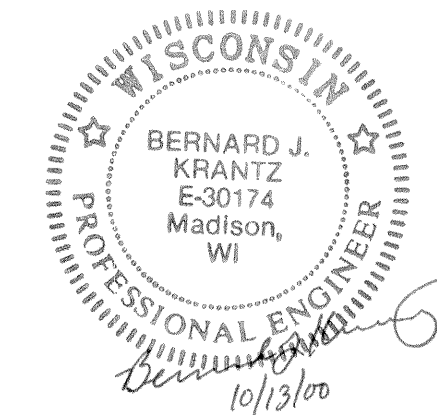

INDEX

SHEET NUMBER	SHEET TITLE
1	TITLE SHEET/INDEX
2	STANDARD LEGEND AND NOTES
3	EXISTING CONDITIONS MAP
4	PROPOSED SUBBASE GRADES
5	PROPOSED BASE GRADES
6	PHASING PLAN- CELL I ACTIVE
7	PHASING PLAN- CELL I CLOSED CELL 2A ACTIVE
8	PHASING PLAN- CELL 1 AND 2A CLOSED CELL 2B ACTIVE
9	PHASING PLAN- CELL 1, 2A, AND 2B CLOSED CELL 3 ACTIVE
10	PHASING PLAN- CELL 1, 2A, 2B AND 3 CLOSED CELL 4A ACTIVE
11	PHASING PLAN- CELL 1, 2A, 2B, 3 AND 4A CLOSED CELL 4B ACTIVE
12	PROPOSED FINAL GRADES
13	PROPOSED ENVIRONMENTAL MONITORING PLAN
14	LONG TERM CARE PLAN
15	ENGINEERING CROSS SECTIONS 171700N AND 172200N
16	ENGINEERING CROSS SECTIONS 1477340E AND 1477710E
17	DETAILS- LINER AND COLLECTION PIPES
18	DETAILS- LEACHATE STORAGE TANK AND MANHOLE
19	DETAILS- FINAL COVER
20	DETAILS- DOWNSLOPE FLUMES
21	DETAILS- DOWNSLOPE FLUMES
22	DETAILS- SEDIMENTATION BASINS
23	DETAILS- MISCELLANEOUS

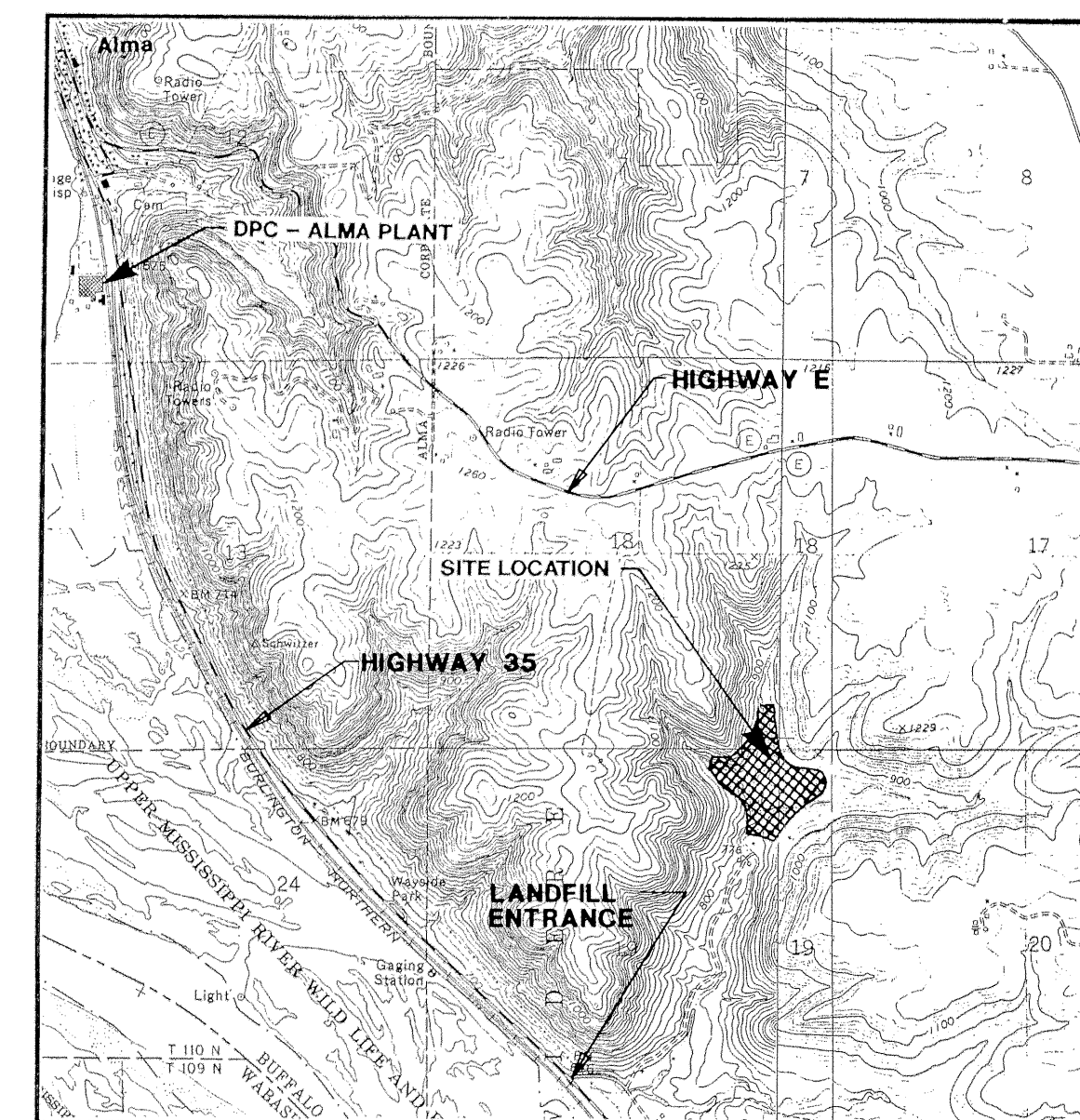
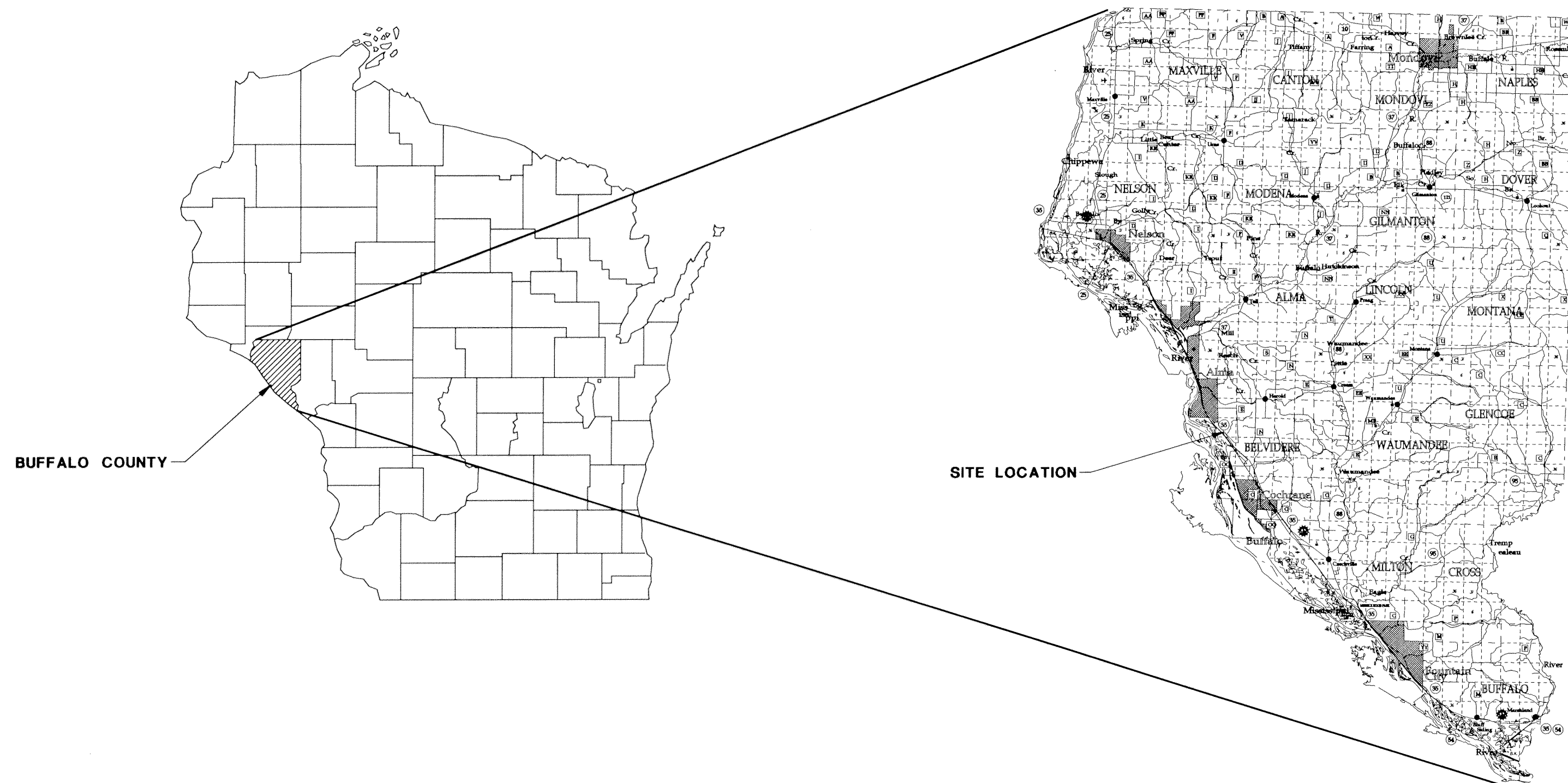

SCALE: 1"=2000'

MAP SOURCE: U.S.G.S. CREAM AND ALMA 7.5' QUADRANGLES, DATE 1974.

WISCONSIN

BUFFALO COUNTY

SITE LOCATION

NOTE: THESE PLANS ARE ACCOMPANIED BY A REPORT OF THE SAME TITLE. THESE DOCUMENTS ARE INTERRELATED AND ARE INTENDED TO BE USED AND REVIEWED TOGETHER. (NOT FOR CONSTRUCTION)



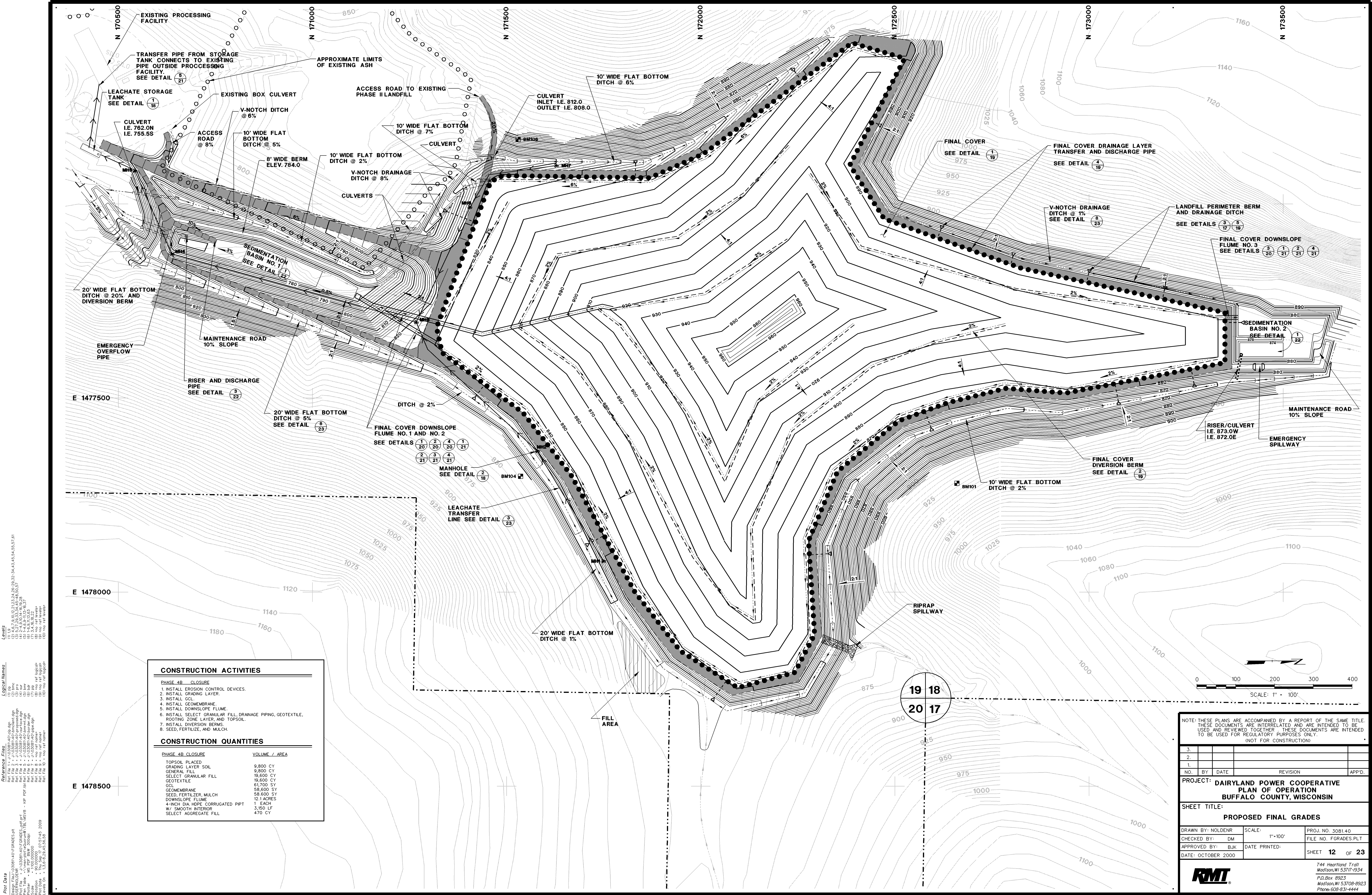

Levels
 (1) 4.67, 7.0, 10.2, 13.2, 16.2, 19.2, 22.2, 25.2, 28.2, 31.2, 34.2, 37.2, 40.2, 43.2, 46.2, 49.2, 52.2, 55.2, 58.2, 61.2, 64.2, 67.2, 70.2, 73.2, 76.2, 79.2, 82.2, 85.2, 88.2, 91.2, 94.2, 97.2, 100.2, 103.2, 106.2, 109.2, 112.2, 115.2, 118.2

Logical Names
 (1) 4.67, 7.0, 10.2, 13.2, 16.2, 19.2, 22.2, 25.2, 28.2, 31.2, 34.2, 37.2, 40.2, 43.2, 46.2, 49.2, 52.2, 55.2, 58.2, 61.2, 64.2, 67.2, 70.2, 73.2, 76.2, 79.2, 82.2, 85.2, 88.2, 91.2, 94.2, 97.2, 100.2, 103.2, 106.2, 109.2, 112.2, 115.2, 118.2

Reference Files
 (1) 4.67, 7.0, 10.2, 13.2, 16.2, 19.2, 22.2, 25.2, 28.2, 31.2, 34.2, 37.2, 40.2, 43.2, 46.2, 49.2, 52.2, 55.2, 58.2, 61.2, 64.2, 67.2, 70.2, 73.2, 76.2, 79.2, 82.2, 85.2, 88.2, 91.2, 94.2, 97.2, 100.2, 103.2, 106.2, 109.2, 112.2, 115.2, 118.2

Plot Data
 Design File: \\03281\40\GRADES\41
 Plot File: \\03281\40\GRADES\41.plt
 Plot Title: \\03281\40\GRADES\41
 Plot Date: 10/20/2000
 Plot Time: 10:20:28
 Plot User: RMT
 Plot Device: HP-GL/2
 Plot Scale: 1" = 100'
 Plot Orientation: Landscape
 Plot Range: Full
 Plot Center: 0,0
 Plot Size: 11.0 x 17.0
 Plot Date: 10/20/2000
 Plot Time: 10:20:28
 Plot User: RMT
 Plot Device: HP-GL/2
 Plot Scale: 1" = 100'
 Plot Orientation: Landscape
 Plot Range: Full
 Plot Center: 0,0
 Plot Size: 11.0 x 17.0

CONSTRUCTION ACTIVITIES	
PHASE 4B CLOSURE	
1. INSTALL EROSION CONTROL DEVICES.	
2. INSTALL GRADING LAYER.	
3. INSTALL GCL.	
4. INSTALL GEOMEMBRANE.	
5. INSTALL DOWNSLOPE FLUME.	
6. INSTALL SELECT GRANULAR FILL, DRAINAGE PIPING, GEOTEXTILE, ROOTING ZONE LAYER, AND TOPSOIL.	
7. INSTALL DIVERSION BERMS.	
8. SEED, FERTILIZE, AND MULCH.	
CONSTRUCTION QUANTITIES	
PHASE 4B CLOSURE	VOLUME / AREA
TOPSOIL PLACED	9,800 CY
GRADING LAYER SOIL	9,800 CY
GENERAL FILL	19,600 CY
SELECT GRANULAR FILL	19,600 CY
GEOTEXTILE	61,700 SY
GCL	58,600 SY
GEOMEMBRANE	58,600 SY
SEED, FERTILIZER, MULCH	12.1 ACRES
DOWNSLOPE FLUME	1 EACH
4-INCH DIA. HDPE CORRUGATED PIPT	3,150 LF
W/ SMOOTH INTERIOR	
SELECT AGGREGATE FILL	470 CY

NOTE: THESE PLANS ARE ACCOMPANIED BY A REPORT OF THE SAME TITLE. THESE DOCUMENTS ARE INTERRELATED AND ARE INTENDED TO BE USED AND REVIEWED TOGETHER. THESE DOCUMENTS ARE INTENDED TO BE USED FOR REGULATORY PURPOSES ONLY. (NOT FOR CONSTRUCTION)

3.					
2.					
1.					
NO.	BY	DATE	REVISION	APP'D.	
PROJECT: DAIRYLAND POWER COOPERATIVE PLAN OF OPERATION BUFFALO COUNTY, WISCONSIN					
SHEET TITLE: PROPOSED FINAL GRADES					
DRAWN BY: NOLDENR	SCALE: 1" = 100'	PROJ. NO. 30B1.40			
CHECKED BY: DM		FILE NO. FGRADES.PLT			
APPROVED BY: BJK	DATE PRINTED:	SHEET 12 OF 23			
DATE: OCTOBER 2000					

744 Heartland Trail
 Madison, WI 53717-9334
 P.O. Box 8923
 Madison, WI 53708-8923
 Phone: 608-931-4444

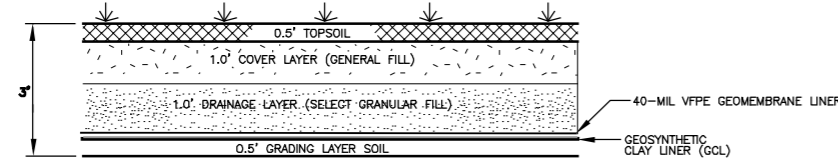

1
19 **FINAL COVER**
(NOT TO SCALE)

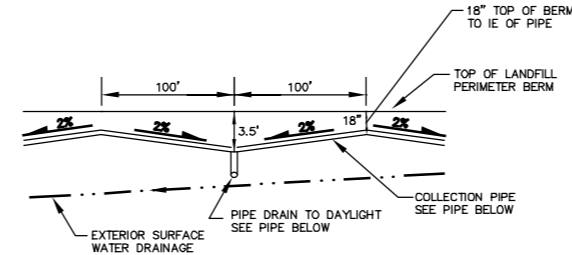

SECTION A-A' OF FINAL COVER DRAINAGE LAYER
NOTE: IN AREAS WHERE THE TOP OF BERM SLOPES, THE COLLECTION PIPE WILL FOLLOW THE SAME SLOPE AS THE TOP OF BERM AND WILL OUTLET THROUGH DISCHARGE PIPES LOCATED AT SPECIFIED INTERVALS. REFER TO PLAN SHEET 12.

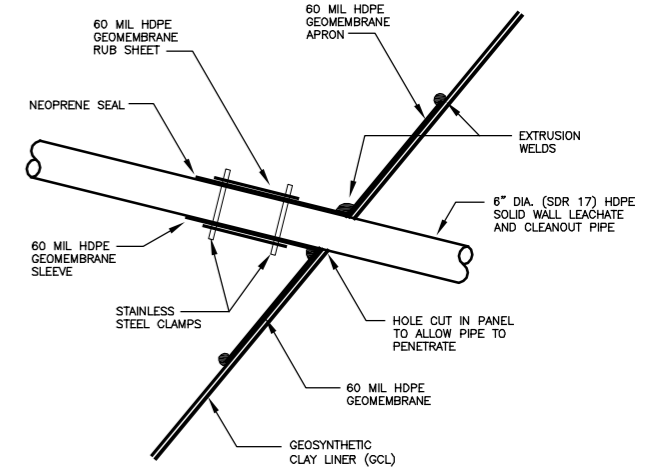

6
19 **PIPE BOOT- PIPES PENETRATING THROUGH FINAL COVER AND LOW PERMEABILITY LAYER (TYPICAL)**
(NOT TO SCALE)

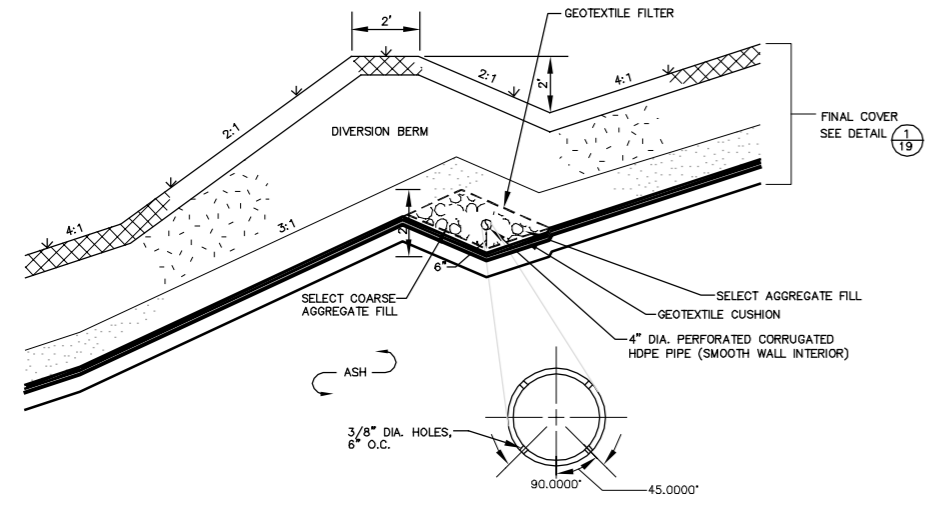

2
19 **SURFACE WATER DIVERSION BERM ON FINAL COVER (TYPICAL)**
(NOT TO SCALE)

NOTE: A 4" DIA. PERFORATED CORRUGATED HDPE PIPE WILL BE LOCATED BELOW EVERY DIVERSION BERM ABOVE THE FINAL COVER EXCEPT THE LOWEST BERM LOCATED NEXT TO THE LANDFILL PERIMETER BERM TO COLLECT WATER IN THE DRAINAGE LAYER ALONG THE PERIMETER BERM PIPES WILL BE CONSTRUCTED IN THE BERM AS SHOWN ON DETAIL 4 OF 19.

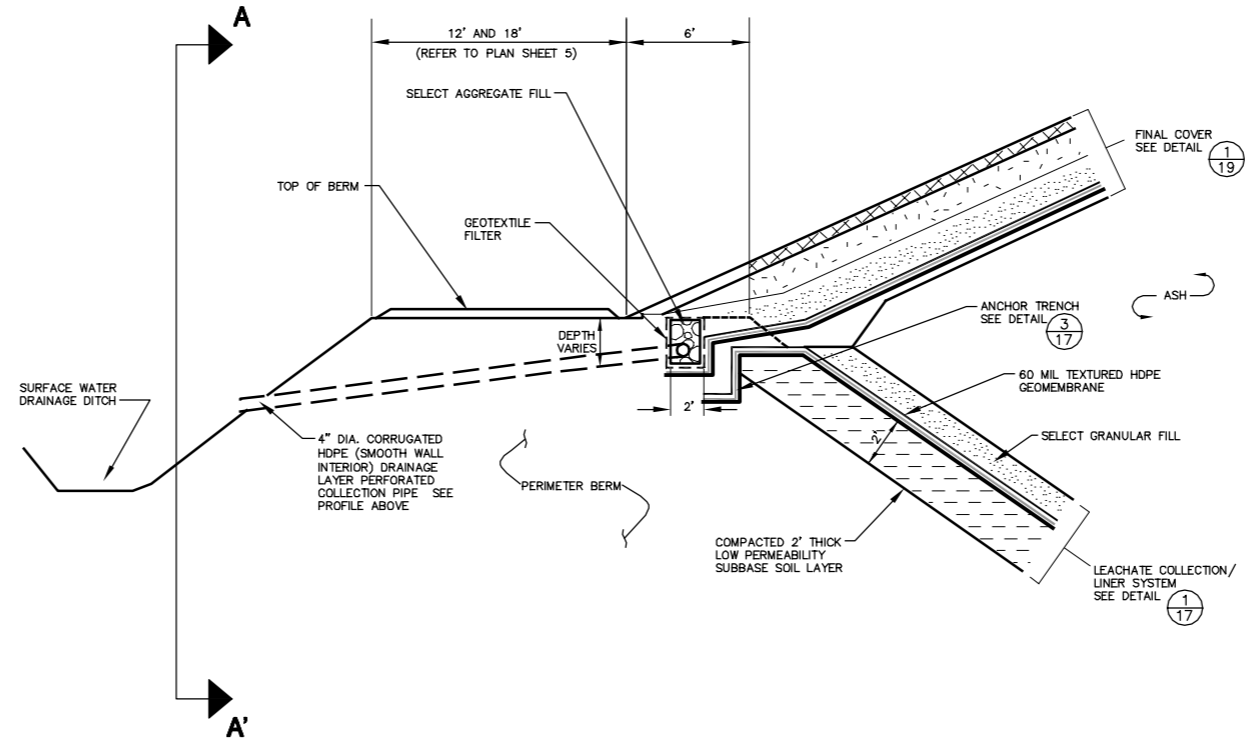

4
19 **PERIMETER BERM FINAL COVER DRAINAGE LAYER DISCHARGE PIPE (TYPICAL)**
(NOT TO SCALE)

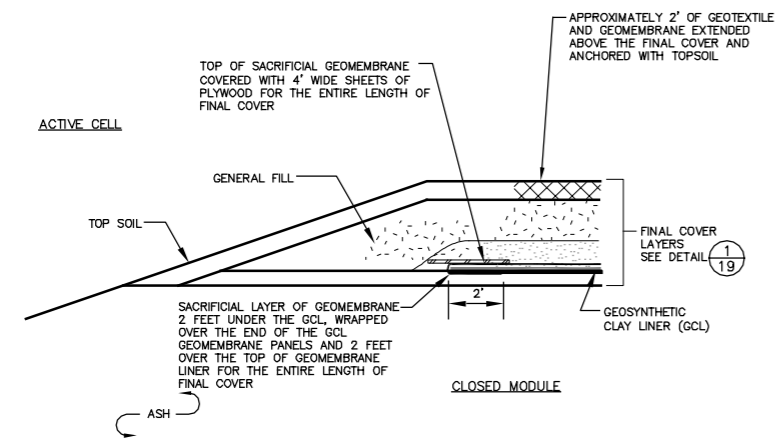

3
19 **CONSTRUCTION OF FINAL COVER FOR SPLICING FUTURE FINAL COVER**
(NOT TO SCALE)

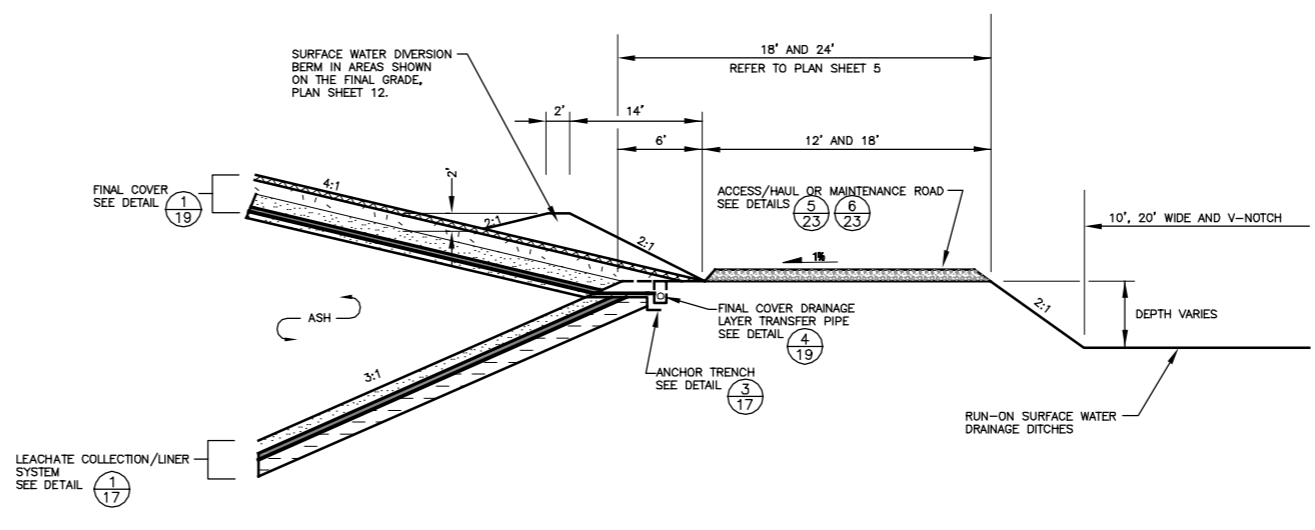

5
19 **LANDFILL PERIMETER BERM AND SURFACE WATER DRAINAGE DITCHES (TYPICAL)**
(NOT TO SCALE)

LINE AND SHADING LEGEND

---	GEOTEXTILE	---	GEOMEMBRANE
----	GEOCOMPOSITE	---	GEOSYNTHETIC CLAY LINER (GCL)
XXXX	TOPSOIL	----	NATIVE SOIL
.....	SELECT GRANULAR FILL DRAINAGE LAYER	----	CONCRETE
.....	PIPE BEDDING MATERIAL	----	RIPRAP
.....	SELECT AGGREGATE FILL	----	GRAVEL
.....	COMPACTED SELECT LOW PERMEABILITY SOIL	----	GENERAL FILL

NOTE: THESE PLANS ARE ACCOMPANIED BY A REPORT OF THE TITLE. THESE DOCUMENTS ARE INTERRELATED AND ARE INTENDED TO BE USED AND REVIEWED TOGETHER. THESE DOCUMENTS ARE INTENDED TO BE USED FOR REGULATORY PURPOSES ONLY. NOT FOR CONSTRUCTION

3.				
2.				
1.				
NO.	BY	DATE	REVISION	APP'D.

PROJECT: **DAIRYLAND POWER COOPERATIVE PLAN OF OPERATION BUFFALO COUNTY, WISCONSIN**

SHEET TITLE: **DETAILS- FINAL COVER**

DRAWN BY: DEF0EJ	SCALE: NOT TO SCALE	PROJ. NO. 3081.40
CHECKED BY: DM	DATE PRINTED:	FILE NO. 30814004.dwg
APPROVED BY: BJK		SHEET 19 OF 23
DATE: OCTOBER 2000		

NOTE: THESE PLANS ARE ACCOMPANIED BY A REPORT OF THE SAME TITLE. THESE DOCUMENTS ARE INTERRELATED AND ARE INTENDED TO BE USED AND REVIEWED TOGETHER. THESE DOCUMENTS ARE INTENDED TO BE USED FOR REGULATORY PURPOSES ONLY. NOT FOR CONSTRUCTION

RMT
744 Heartland Trail
Madison, WI 53717-1934
P.O. Box 8923
Madison, WI 53708-8923
Phone: 608/831-4444

RMT COMPUTER AIDED DESIGN & DRAWING
 8300 WISCONSIN AVENUE, SUITE 100, MADISON, WI 53717
 608/831-4444 FAX 608/831-4445
 WWW.RMT.COM

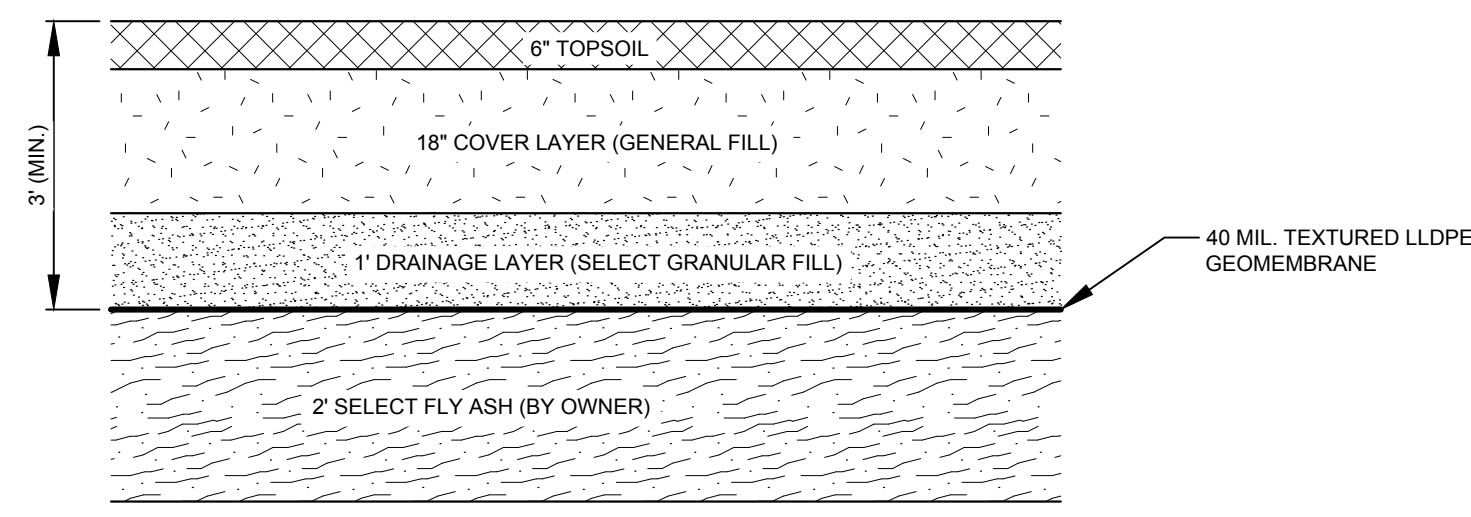

1
12 FINAL COVER (NOT TO SCALE)

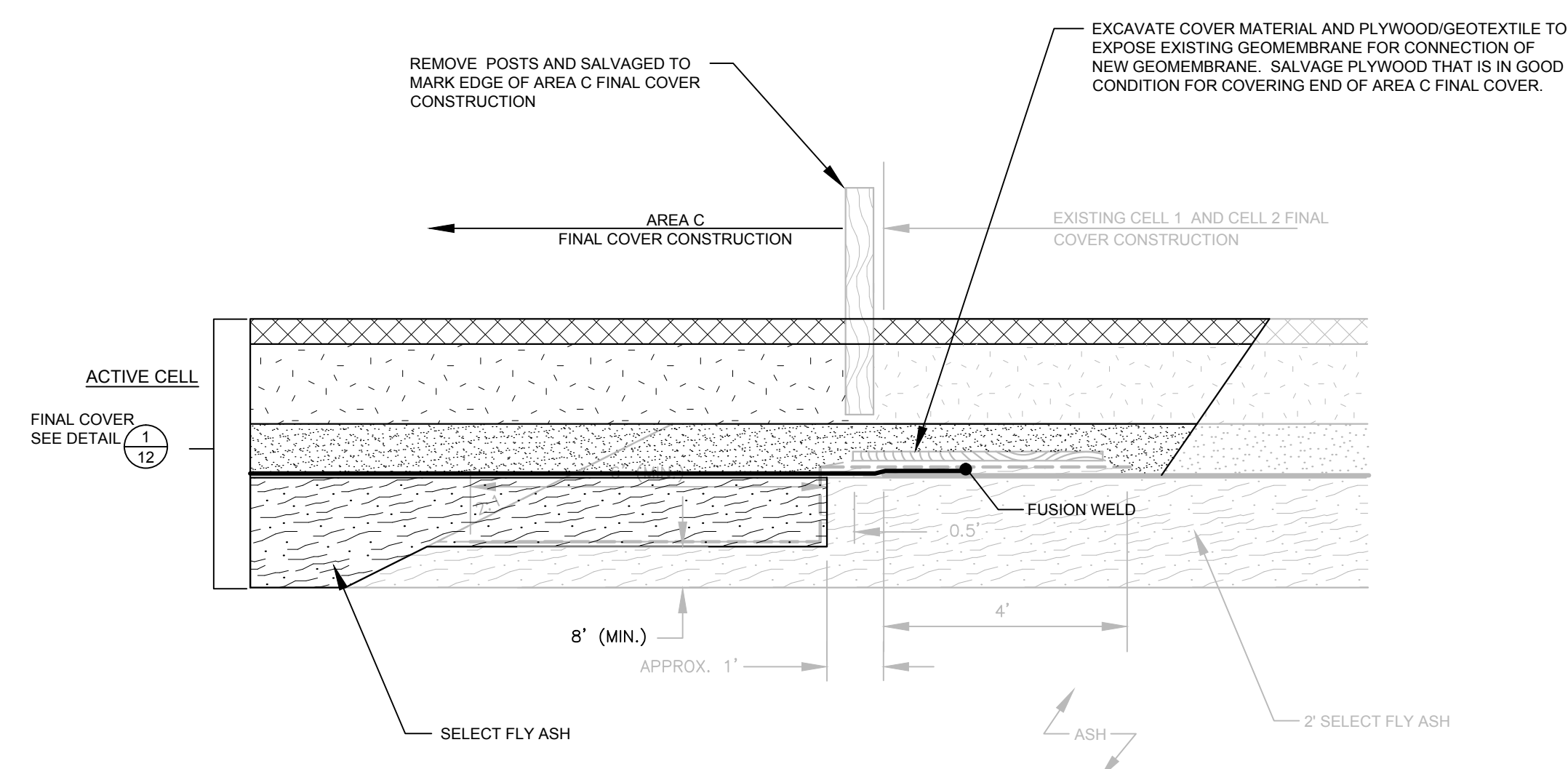

2
12 FINAL COVER CONNECTION (NOT TO SCALE)

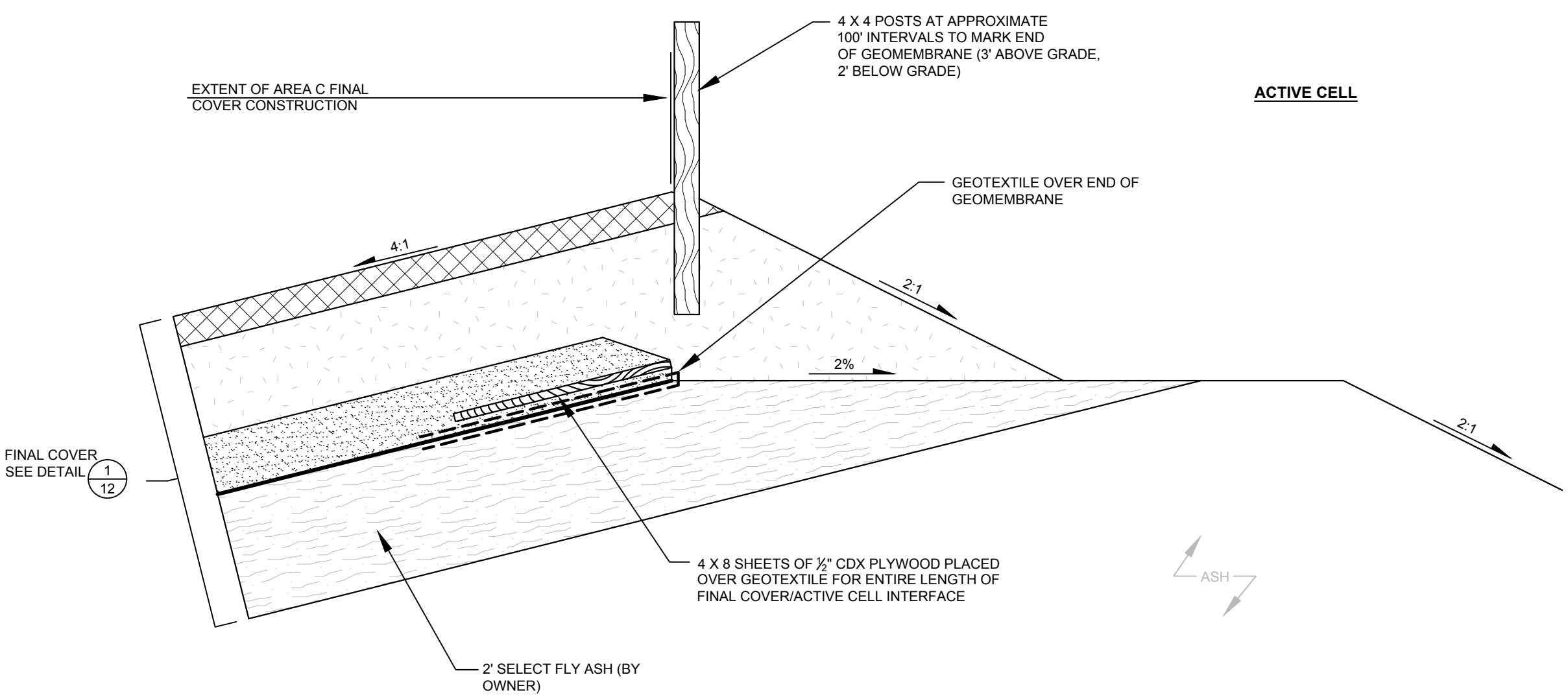

3
12 FINAL COVER TRANSITION (NOT TO SCALE)

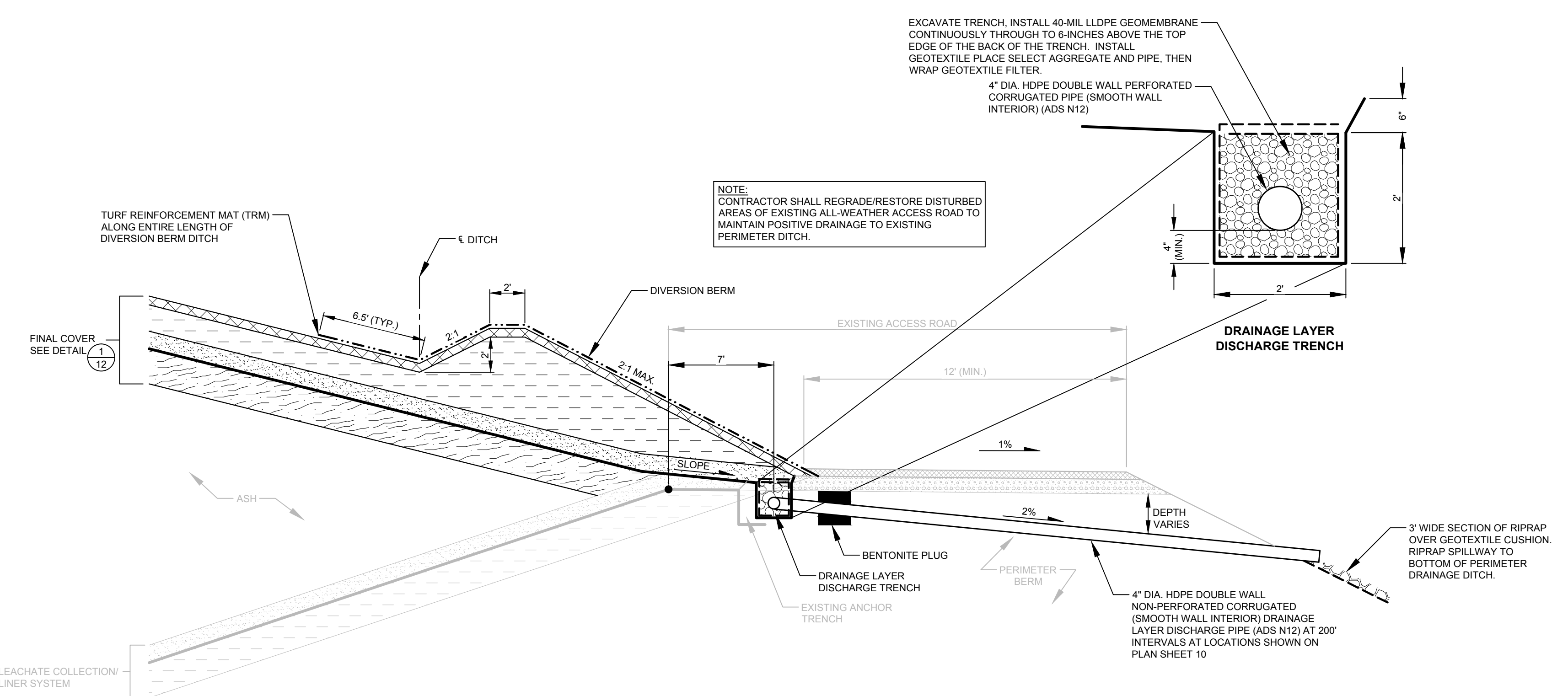

4
12 FINAL COVER TERMINATION WITH TOE DRAIN DISCHARGE PIPE (NOT TO SCALE)

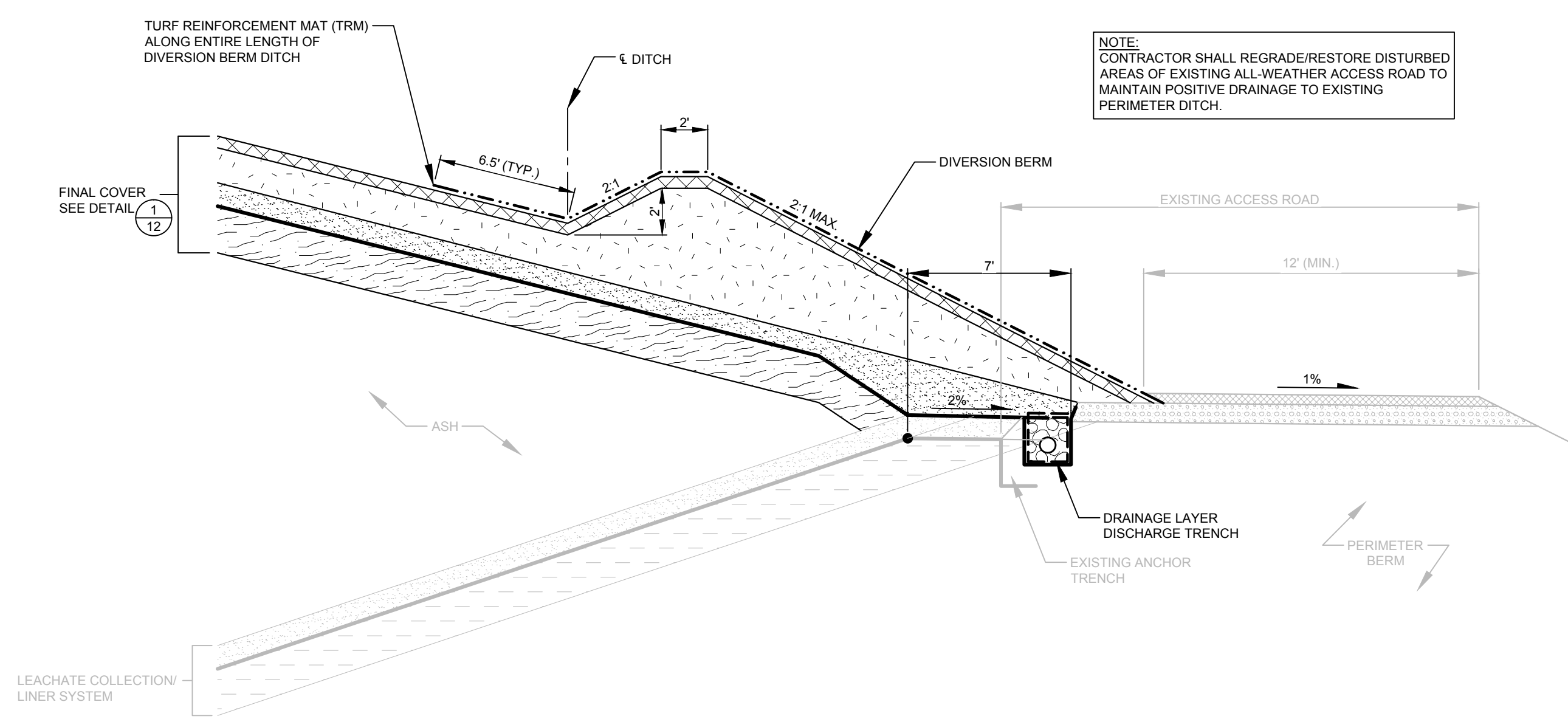

5
12 FINAL COVER TERMINATION (OVER CELL 1 LINER CONSTRUCTION) (NOT TO SCALE)

NOTE: THE CONTRACTOR SHALL NOTIFY ALL AREA UTILITY COMPANIES PRIOR TO COMMENCING WORK ON THIS CONTRACT, IN ACCORDANCE WITH STATE AND LOCAL REQUIREMENTS.
NOTE: THESE PLANS ARE ACCOMPANIED BY A PROJECT MANUAL OF THE SAME TITLE. THESE DOCUMENTS ARE INTERRELATED AND ARE INTENDED TO BE USED TOGETHER.

NO.	BY	DATE	REVISION	APPD.

PROJECT: DAIRYLAND POWER COOPERATIVE
PHASE IV, CELL 3B LINER CONSTRUCTION & AREA C (OVER CELLS 1 & 2)
FINAL COVER CONSTRUCTION
BUFFALO COUNTY, WISCONSIN

SHEET TITLE: DETAILS

DRAWN BY: LSTORMER	SCALE: AS SHOWN	PROJ. NO: 216851 0005
CHECKED BY: DM	DATE PRINTED: MARCH 2015	FILE NO: 016851.0004.SHT12-DT.dwg
APPROVED BY: TWMM	DATE: MARCH 2015	SHEET 12 OF 13

J:\Dairyland Power\Area3\16851\0004\SHT12-DT.dwg
 Drawing Name: STORMER, LARRY
 Drawing Size: 11x17
 Date: 03/11/2015
 Plot Time: 1:24 PM
 SHEET 12
 Attached Xrefs:
 Attached Images:

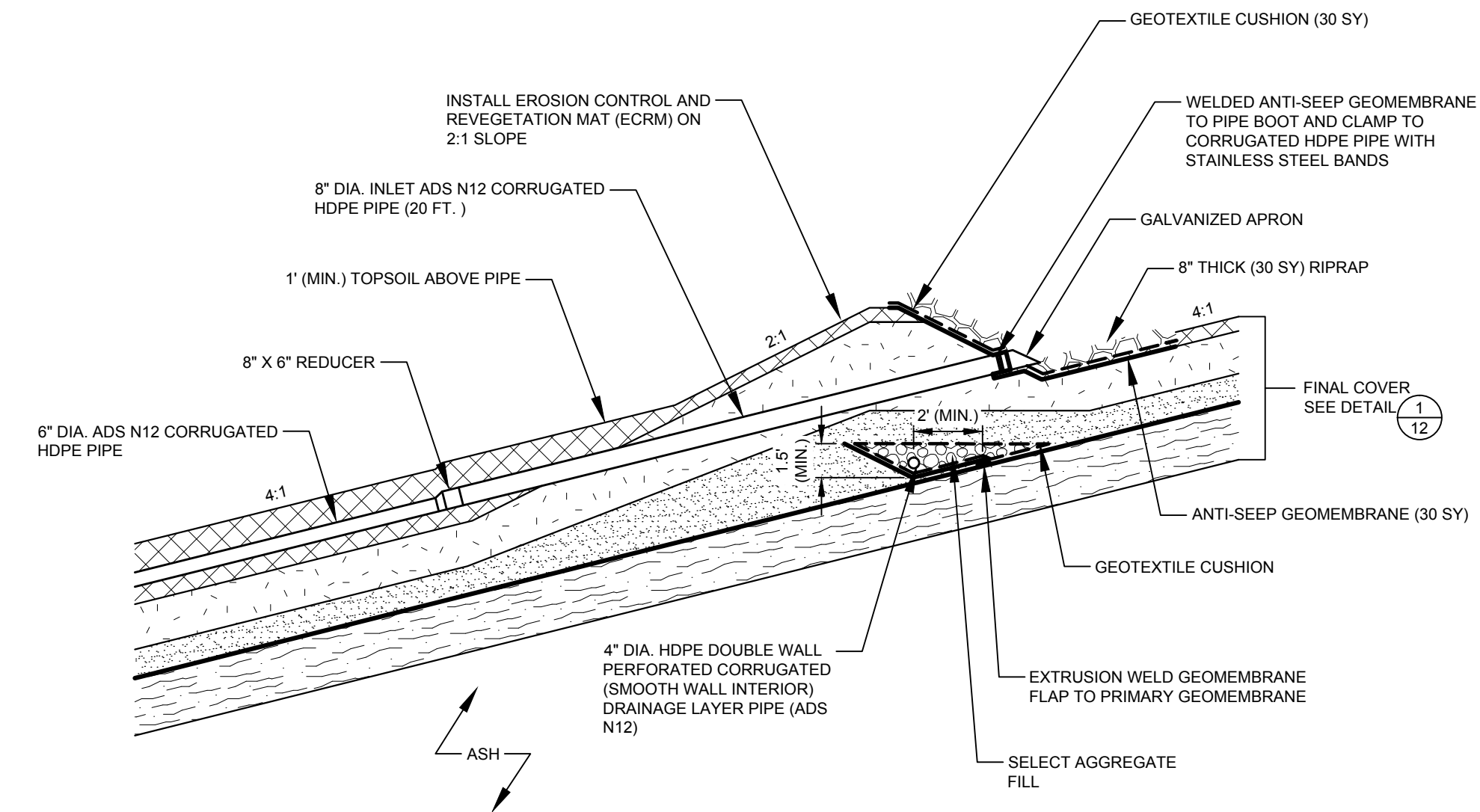

1
13 ————— **8" DIA. INLET STRUCTURE**
(NOT TO SCALE)

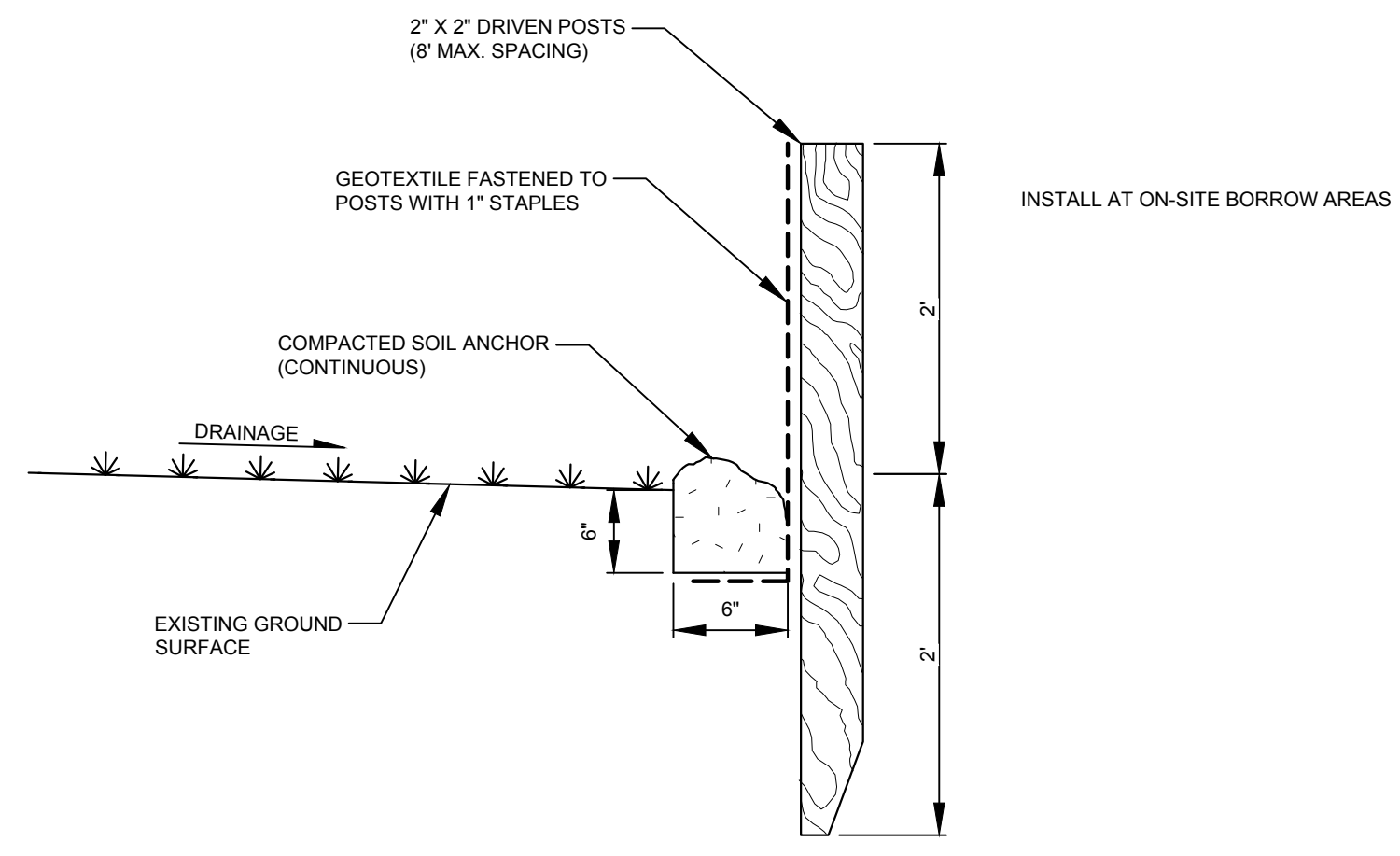

3
13 ————— **SEDIMENT CONTROL FENCE**
(NOT TO SCALE)

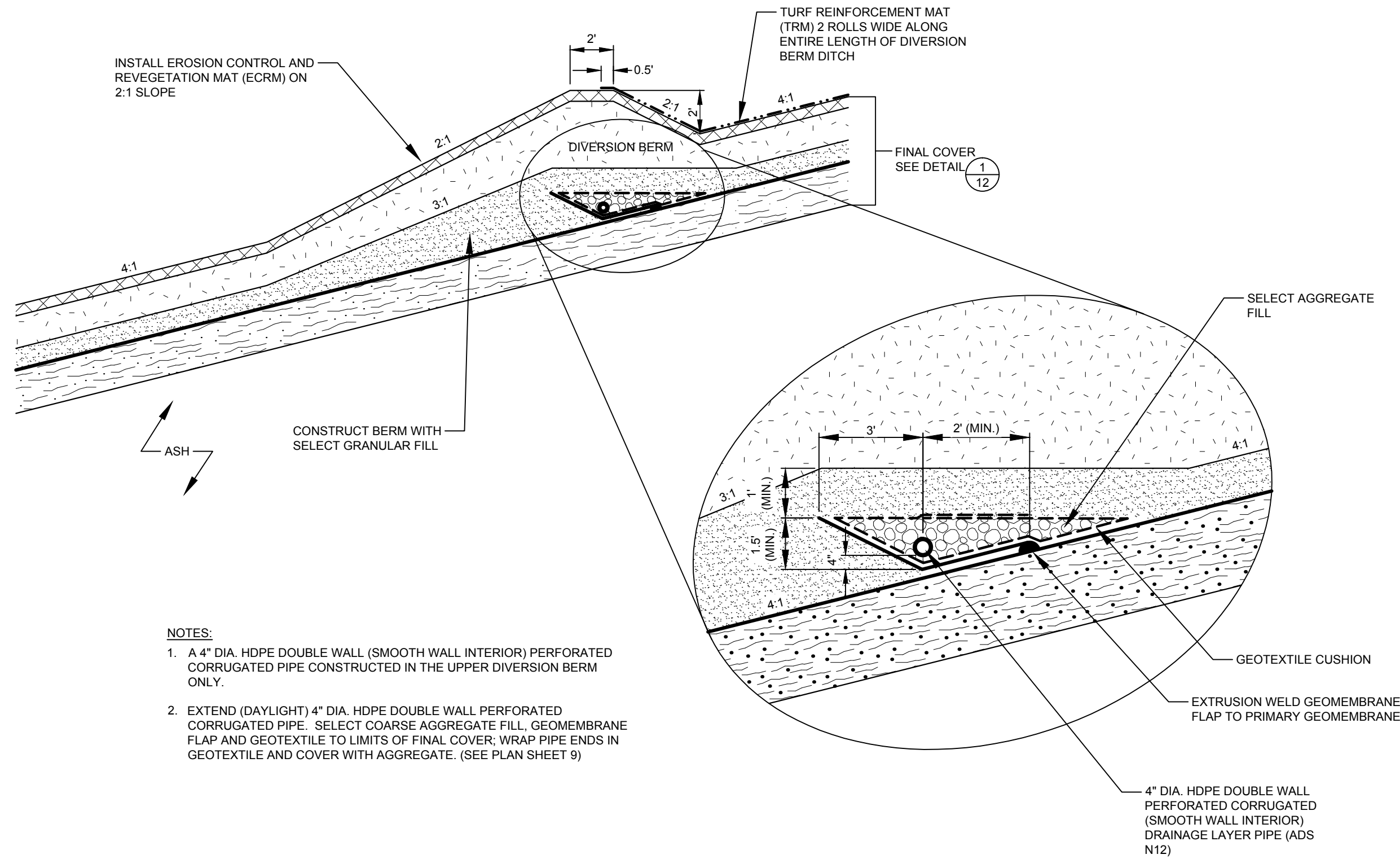

2
13 ————— **DIVERSION BERM**
(NOT TO SCALE)

- NOTES:**
1. A 4" DIA. HDPE DOUBLE WALL (SMOOTH WALL INTERIOR) PERFORATED CORRUGATED PIPE CONSTRUCTED IN THE UPPER DIVERSION BERM ONLY.
 2. EXTEND (DAYLIGHT) 4" DIA. HDPE DOUBLE WALL PERFORATED CORRUGATED PIPE. SELECT COARSE AGGREGATE FILL, GEOMEMBRANE FLAP AND GEOTEXTILE TO LIMITS OF FINAL COVER. WRAP PIPE ENDS IN GEOTEXTILE AND COVER WITH AGGREGATE. (SEE PLAN SHEET 9)

NOTE: THE CONTRACTOR SHALL NOTIFY ALL AREA UTILITY COMPANIES PRIOR TO COMMENCING WORK ON THIS CONTRACT, IN ACCORDANCE WITH STATE AND LOCAL REQUIREMENTS.

NOTE: THESE PLANS ARE ACCOMPANIED BY A PROJECT MANUAL OF THE SAME TITLE. THESE DOCUMENTS ARE INTERRELATED AND ARE INTENDED TO BE USED TOGETHER.

NO.	BY	DATE	REVISION	APPD.

PROJECT: **DAIRYLAND POWER COOPERATIVE
PHASE IV, CELL 3B LINER CONSTRUCTION & AREA C (OVER CELLS 1 & 2)
FINAL COVER CONSTRUCTION
BUFFALO COUNTY, WISCONSIN**

SHEET TITLE: **DETAILS**

DRAWN BY: LSTORMER	SCALE: AS SHOWN	PROJ. NO: 216851 0005
CHECKED BY: DM	DATE PRINTED:	FILE NO: 016851.0004.SHT13-DT.dwg
APPROVED BY: TWMM	DATE: MARCH 2015	SHEET 13 OF 13

PLOT DATE: J:\Dairyland Power\AreaC\16851\0004\216851\0004.SHT13-DT.dwg
 Drawing Name: STORMER, LARRY
 Drawing Size: 13x19
 Date: 3/13/2015
 Plot Time: 10:47 AM
 Attached Xrefs: Attached Images